



**A4**  
Saloon | Avant

Audi  
Vorsprung durch Technik 

You drive this.









# You feel that.

Design and technology that lead the way. Sporty and pioneering. United in the new Audi A4 Saloon and the new Audi A4 Avant. See for yourself.

The fuel consumption and CO<sub>2</sub> emission figures can be found from page 68 onwards.

**Progressive design –**  
clear surfaces, sharp lines, distinctive style.



The powerful-looking front end, the three-dimensional Singleframe and the sporty, elegant design. The Audi A4 Saloon and the Audi A4 Avant: exciting, inspiring, captivating.



The fuel consumption and CO<sub>2</sub> emission figures can be found from page 68 onwards.



Dynamic, precise, succinct. From the front end to the distinct diffuser with integrated tailpipes. Rounded off by optional LED rear lights with dynamic indicators in a progressive design.





The fuel consumption and CO<sub>2</sub> emission figures can be found from page 68 onwards.



A saloon with a new design language. Emphatically sporty. Strikingly staged. By the straight roof line and the crisp, all-round shoulder line with gently tapering shadow edge.



The fuel consumption and CO<sub>2</sub> emission figures can be found from page 68 onwards.



# L i g h t s   o n .



The fuel consumption and CO<sub>2</sub> emission figures can be found from page 68 onwards.

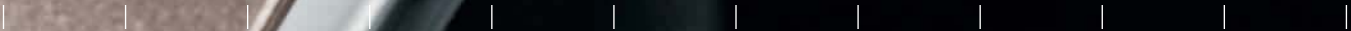

# N i g h t o f f .

The fuel consumption and CO<sub>2</sub> emission figures can be found from page 68 onwards.







The fuel consumption and CO<sub>2</sub> emission figures can be found from page 68 onwards.





**Audi Matrix LED headlights –**  
see and be seen.

A shining example of progressiveness: the crystal-like light from the optional Matrix LED headlights casts a bright, uniform light across the road.

**R o a r i n g e n g i n e .**



The fuel consumption and CO<sub>2</sub> emission figures can be found from page 68 onwards.

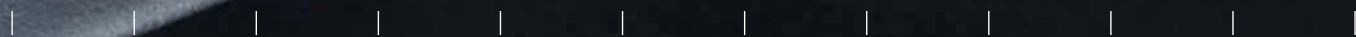



# Beating heart.

The fuel consumption and CO<sub>2</sub> emission figures can be found from page 68 onwards.



**New TFSI® and  
TDI® engines –  
breathtaking performance, lower fuel consumption.**

Many engines, one principle: more power, lower fuel consumption. TFSI and TDI engines of the latest generation. From the 2.0 TFSI and the 2.0 TDI to the 3.0 TDI quattro. Powerful performance with reduced emissions. Experience driving dynamics and efficiency with virtually no compromise.





The fuel consumption and CO<sub>2</sub> emission figures can be found from page 68 onwards.





**Modern driver assistance systems –**  
arrive more relaxed and also save fuel.

The fuel consumption and CO<sub>2</sub> emission figures can be found from page 68 onwards.

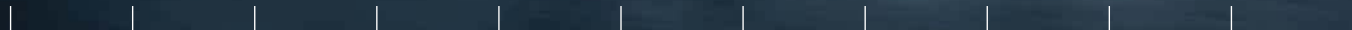





More comfort, greater safety and reduced fuel consumption. Assured by an intelligent combination of newly developed assistance systems. As an option, the predictive efficiency assistant helps you to adopt an anticipatory driving style for fuel savings of up to 10%. adaptive cruise control with Stop&Go function including congestion assistant will make driving easier in slow-moving traffic, and at speeds of up to 65 km/h will even help to steer the car. The next step towards piloted driving.



quattro® –  
enhanced dynamics, traction and safety.

Agility in everyday driving and beyond. Stick to the road. Wherever and whenever you want. With the optional quattro all-wheel drive. More traction in virtually every situation. Exhilarating dynamics. Thrilling handling characteristics that you won't ever want to lose.

The fuel consumption and CO<sub>2</sub> emission figures can be found from page 68 onwards.

# Virtual cockpit.





900 km | Purple Rain In The Dark

2,9 km  
117 km  
23:45

0  
km/h

22:31

+22,5°C

The fuel consumption and CO<sub>2</sub> emission figures can be found from page 68 onwards.



# Real excitement.

Focus on the future of mobility. With the optional Audi virtual cockpit. Fully digital instrument cluster with high-resolution 12.3-inch colour display. A high level of function and design. Few buttons, many functions. Plus Audi MMI and, on request, the head-up display that projects additional information onto the windscreen. Experience infotainment on a grand scale. Right here in your Audi A4.

The fuel consumption and CO<sub>2</sub> emission figures can be found from page 68 onwards.

MMI® and  
Audi smartphone interface –  
your personal data environment integrated  
and intuitively controlled.







Everything under control. Driver-oriented and tailored to you. The familiar world of your smartphone with the optional Audi smartphone interface. Presented on the high-resolution MMI display. In brilliant colour. And for even more entertainment, convenience and safety, there are the innovative Audi connect services<sup>1</sup>. Up-to-date data delivered at top speed thanks to the LTE<sup>2</sup> mobile communication standard. Why not see for yourself.

<sup>1</sup> Legal information and terms of use can be found on page 75. <sup>2</sup> Full use requires LTE card contract. For information about the availability and use of LTE support, please contact your Audi partner.

Turn it up.

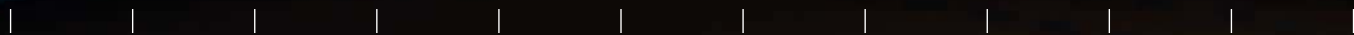

BANG & OLUFSEN





Be in the front row.

Almost like in a concert hall. The optional Bang&Olufsen 3D Sound System raises musical enjoyment to a new level. Assured by an amplifier output of 755 watts and 19 loudspeakers. Midrange speakers and tweeters specially integrated into the A-pillar create a three-dimensional sound that reproduces the full depth of the music. And with a precision that will give you a fascinating in-car experience.

The fuel consumption and CO<sub>2</sub> emission figures can be found from page 68 onwards.



The image shows the front interior of an Audi Quattro. The dashboard and center console are finished with dark wood grain. The seats are upholstered in rich brown leather. A large digital display is mounted on the dashboard, showing various icons for navigation, telephone, and Audi connect. The center console features a gear selector and a rotary dial. The overall design is sleek and modern.

## Interior design – innovative architecture, sophisticated ambience, impressive quality.

High tech, functionality and design. Impressively and harmoniously combined in the interior. Horizontal interior architecture. Exuding lightness and breadth. High-quality materials, sophisticated tactile qualities and precision workmanship. Plus headroom, shoulder room and legroom that ensure a wonderful sense of space. The optional ambient lighting with its range of colours creates an atmosphere of well-being.

The fuel consumption and CO<sub>2</sub> emission figures can be found from page 68 onwards.

**Functional interior –**  
comfortable environment,  
generously spacious.



The interior concept in the new Audi A4 Avant. Well thought-out down to the last detail. From the generous amount of space for all passengers through to the impressive luggage capacity. With optional sensor-controlled luggage compartment lid release. A movement of the foot is all that's required. For fast, convenient loading and unloading. Without having to search for the key.



The all-new Audi A4:  
Progress is intense.





The fuel consumption and CO<sub>2</sub> emission figures can be found from page 68 onwards.



01 | 02 | 03 — — —

# More varied. A brief glimpse into a world of possibilities.

The Audi A4 – an exceptional car whose diverse range of high-quality equipment will impress you. As will many other highlights – let yourself be inspired.

- 01\_ Parking assistance package (360 degree cameras, park assist) – makes parking and manoeuvring easier
- 02\_ Tour assistance package (includes congestion assistant, predictive efficiency assistant, camera-based recognition of traffic signs, high-beam assist, Audi active lane assist) – provides assistance on motorways and country roads
- 03\_ City assistance package (includes exit warning, cross traffic assist rear, Audi side assist, parking system plus, reversing camera) – for greater safety and convenience in city traffic
- 04\_ MMI® navigation plus with MMI touch – multimedia functions and intuitive control
- 05\_ Audi connect\* – digital networking – stay in touch with the world when on the road
- 06\_ Head-up display – on request projects information relevant to the driver onto the windscreen in the driver's direct field of view

The model-specific standard and optional equipment can be found in the index from page 72 onwards. The fuel consumption and CO<sub>2</sub> emission figures can be found from page 68 onwards.

\*Legal information and terms of use can be found on page 75.



04



05



06





10

- 07\_ Ambient lighting – 3 pre-defined colour profiles ensure a relaxed atmosphere tailored to your individual preferences
- 08\_ Sport or comfort suspension with damper control – dynamic or comfort-oriented characteristics for damper settings; adjusted via Audi drive select
- 09\_ Audi tablet including Rear Seat Entertainment<sup>1</sup> – fully integrated and networked entertainment feature for use on the road
- 10\_ Convenience key including sensor-controlled luggage compartment release and electrically opening and closing luggage compartment lid
- 11\_ Panoramic glass sunroof – ensures an interior ambience that is flooded with light and improves the interior climate
- 12\_ Audi exclusive titanium black gloss package<sup>2,3</sup> – adds exclusive highlights in black

The model-specific standard and optional equipment can be found in the index from page 72 onwards. The fuel consumption and CO<sub>2</sub> emission figures can be found from page 68 onwards.

<sup>1</sup> Legal information and terms of use can be found on page 75. <sup>2</sup> From quattro GmbH.

<sup>3</sup> For information on when this feature will be available, please contact your Audi partner.



11



12

# More exceptional. With A4 design and Audi design selection.

In an Audi A4, there is plenty of scope for your own ideas. The A4 design line allows you to create striking accents that reflect your personality. Make an exceptional vehicle even more exceptional. This can be stylishly achieved with the Audi design selection, which offers an attractive range of special materials and colours for the interior. Our designers have combined selected inlays with exquisite leather seats featuring attractive contrasting stitching.





**01\_ A4 design** – includes cast aluminium wheels in 10-spoke crystal design – rear diffuser insert in matt titanium black – aluminium inlays in the door handles – further distinctions in the interior

**02\_ Audi design selection** – including seat upholstery in fine Nappa leather, cedar brown; optionally in rock grey or Atlas beige with contrasting stitching and piping – leather steering wheel in 3-spoke design with multifunction plus and chrome trim – optional inlays in oak, natural grey **03\_ Audi design selection** – interior elements in artificial leather in cedar brown with contrasting stitching in granite grey – cast aluminium wheels in 10-spoke dynamic design, partly polished\* Many more highlights can be found at [www.audi.com](http://www.audi.com)





# More sporty.

## With A4 sport and the S line sport package.

The A4 sport equipment version lets you show your sporty side – all along the line. With details that impressively emphasise the character of your Audi A4 and, at the very first glance, leave you in no doubt of its powerful performance. The S line sport package offers even more highlights that further enhance the vehicle's sporty character.

**01\_ S line sport package** – including sport seats, front, with S embossing in the backrests – S line seat upholstery in fine Nappa leather, rotor grey; optionally in black – interior, dashboard and headlining in black – S line sport leather steering wheel in 3-spoke design with multifunction plus – inlays in matt brushed aluminium – pedals and footrest in stainless steel **02\_ S line sport package** – cast aluminium wheels in 5-twin-spoke star design (S design) **03\_ A4 sport** – including cast aluminium wheels in 5-spoke Y design – radiator grille in matt twilight grey – side air inlet grilles in matt titanium black – further distinctions in the interior  
Many more highlights can be found at [www.audi.com](http://www.audi.com)



03





04

**01\_** Including side sill trims painted in body colour **02\_** Door sill trims, front, with aluminium inlay and S logo, illuminated **03\_** Diffuser insert in matt twilight grey – rear bumper insert with honeycomb structure **04\_** Radiator grille in matt twilight grey, chrome slats – side air inlet grilles in matt titanium black with chrome trim  
Many more highlights can be found at [www.audi.com](http://www.audi.com)

# More striking.

## With the S line exterior package.

Don't just emphasise the sporty character of your Audi A4, enhance it. With the S line exterior package, you give the dynamic lines of your car an even more exhilarating edge and create special accents with exceptional design details.



01

**01\_** Leather upholstery and trim (package 1) in Audi exclusive fine Nappa leather with sport seats, front, in cognac/black – Audi exclusive leather controls in black with contrasting stitching in cognac – inlays in piano finish, black – door trim inserts in Alcantara, black – Audi exclusive floor mats, edging and stitching in black, piping in cognac **02\_** Audi A4 Avant with Audi exclusive customised paint finish in sprint blue, pearl effect – Audi Sport cast aluminium wheels in 10-V-spoke design, gloss turned finish<sup>1</sup> – Audi exclusive titanium black gloss package<sup>2</sup>

Audi exclusive is from quattro GmbH. The fuel consumption and CO<sub>2</sub> emission figures can be found from page 68 onwards.

<sup>1</sup>Please note the special information relating to wheels on page 71. <sup>2</sup>For information on when this feature will be available, please contact your Audi partner.



# More unmistakable. With Audi exclusive.

Make your Audi A4 unique – as unmistakable as you are – with Audi exclusive. With selected trim, coloured leather and customised paint finishes in a wide range of colours. Just as you wish. Your Audi partner and the Audi exclusive Studio of the Audi Forum Neckarsulm await your wishes.

01

02

03

04

05

06

07





# Powerful look.

Select the paint colour that best suits your personality. Secure in the knowledge that the quality will be superb, because your vehicle is painted not just once, but four times. So not only do you look radiant in your Audi, your car is also protected from environmental influences and wear. Ensuring that the car maintains a powerful look throughout its entire lifetime.



01\_ Audi exclusive customised paint finish in sprint blue, pearl effect\*  
02\_ Scuba blue, metallic 03\_ Moonlight blue, metallic 04\_ Daytona grey, pearl effect  
05\_ Manhattan grey, metallic 06\_ Tango red, metallic 07\_ Argus brown, metallic  
08\_ Floret silver, metallic 09\_ Glacier white, metallic  
Many more paint finishes can be found at [www.audi.com](http://www.audi.com)

02  
17-inch



04  
18-inch



01  
19-inch

03  
19-inch



05  
18-inch





06  
18-inch

07  
18-inch



08  
18-inch

## Powerful presence.

With Audi wheels, you can emphasise your own individual style and the character of your Audi A4. Why not indulge yourself and create a powerful presence with your favourite design. And for peace of mind when out on the road: Audi wheels are subjected to special test procedures, undergo rigorous testing and are of superb quality.

01\_ 19" Audi Sport cast aluminium wheels in 5-V-spoke design in matt titanium look, gloss turned finish, with RS logo<sup>1,2</sup> 02\_ 17" cast aluminium wheels in 10-spoke crystal design 03\_ 19" Audi Sport cast aluminium wheels in 10-V-spoke design<sup>1</sup> 04\_ 18" cast aluminium wheels in 5-spoke dynamic design, contrasting grey, partly polished<sup>2</sup> 05\_ 18" cast aluminium wheels in 5-twin-spoke star design (S design) 06\_ 18" cast aluminium wheels in 5-twin-spoke design, contrasting grey, partly polished<sup>2</sup> 07\_ 18" Audi Sport cast aluminium wheels in 5-arm pylon design in matt black, gloss turned finish<sup>1,2</sup> 08\_ 18" Audi Sport cast aluminium wheels in 5-twin-spoke design, with RS logo<sup>1</sup>

Many more wheels can be found at [www.audi.com](http://www.audi.com)

# More sophisticated. With cloth and leather upholstery.

You have a special place in your Audi. Exclusive comfort can be felt on the front and rear seats: thanks to high-quality materials and first-class workmanship. No matter which seat upholstery you choose: you're sitting in the right place.

Sport seats, front, in fine Nappa leather, cedar brown (illustration shows Audi design selection)

Concept cloth, black

Alcantara/leather, rock grey  
with contrasting stitching

Fine Nappa leather, Atlas beige  
with contrasting stitching and piping  
in granite grey

Audi exclusive leather upholstery  
and trim  
From quattro GmbH

The model-specific standard and optional equipment can be found in the index from page 72 onwards.

Audi exclusive



Sport seats, front, in fine Nappa leather, rotor grey (illustration shows S line sport package)

System cloth, black-red

Leather/artificial leather, perforated, nougat brown

Alcantara/leather, rotor grey with contrasting stitching

Fine Nappa leather, black with contrasting stitching

**M o r e r e f i n e d .**  
**W i t h i n l a y s .**

Aluminium ellipse

Matt brushed aluminium

Aluminium trimaran



Exclusive ambience is a question of style. Your style. A style you can refine down to the last detail. Create tangible accents with high-quality Audi inlays. Experience the fascination of selected materials: fine woods, piano finish or aluminium trim – combine them to suit your own individual taste.

The model-specific standard and optional equipment can be found in the index from page 72 onwards.



**Piano finish, black**  
From quattro GmbH



**Audi exclusive wood inlays**  
From quattro GmbH

Audi exclusive

# As individual as the life you lead.

Audi Genuine Accessories provides you with numerous ways of adding even more facets to your Audi A4. With products that keep our quality promise day in, day out. Benefit from customised solutions that offer a winning combination of fascinating design and high functionality. Further information on these and other highlights is available from your Audi partner.

- 01\_** Ski and luggage boxes in a new Audi design, lockable and can be opened on both sides for convenience. Available in sizes 300 l, 360 l and 405 l
- 02\_** Partition grille for the luggage compartment of the Audi A4 Avant. Easily installed behind the rear seats, no drilling required
- 03\_** Audi Entertainment mobile with 10-inch touch screen display promises first-rate entertainment with excellent picture quality
- 04\_** Exterior mirror housings in high-quality carbon create a visual highlight and also save weight
- 05\_** Audi child seat youngster plus combines safety with superior comfort. Suitable for children from 15 to 36 kg (approximately 4 to 12 years)
- 06\_** Cast aluminium wheels in size 8.5 J x 19 and featuring a 5-arm sidus design ensure a dynamic presence

The fuel consumption and CO<sub>2</sub> emission figures can be found from page 68 onwards.



Further information can be obtained from the Audi A4 accessories catalogue, at [www.audi.com](http://www.audi.com), and from your Audi partner.





02



03



04



64 | 65

05



06



# The fascination of the Audi A4. Find out more online.

Discover the world of the new A4. More information, more individuality and more exclusivity. Now at [www.audi.com](http://www.audi.com)



Place your NFC-compatible smartphone/tablet (Android) on this symbol to connect to the digital world of the A4.



Scan the QR code with a smartphone or tablet and discover the world of the A4.

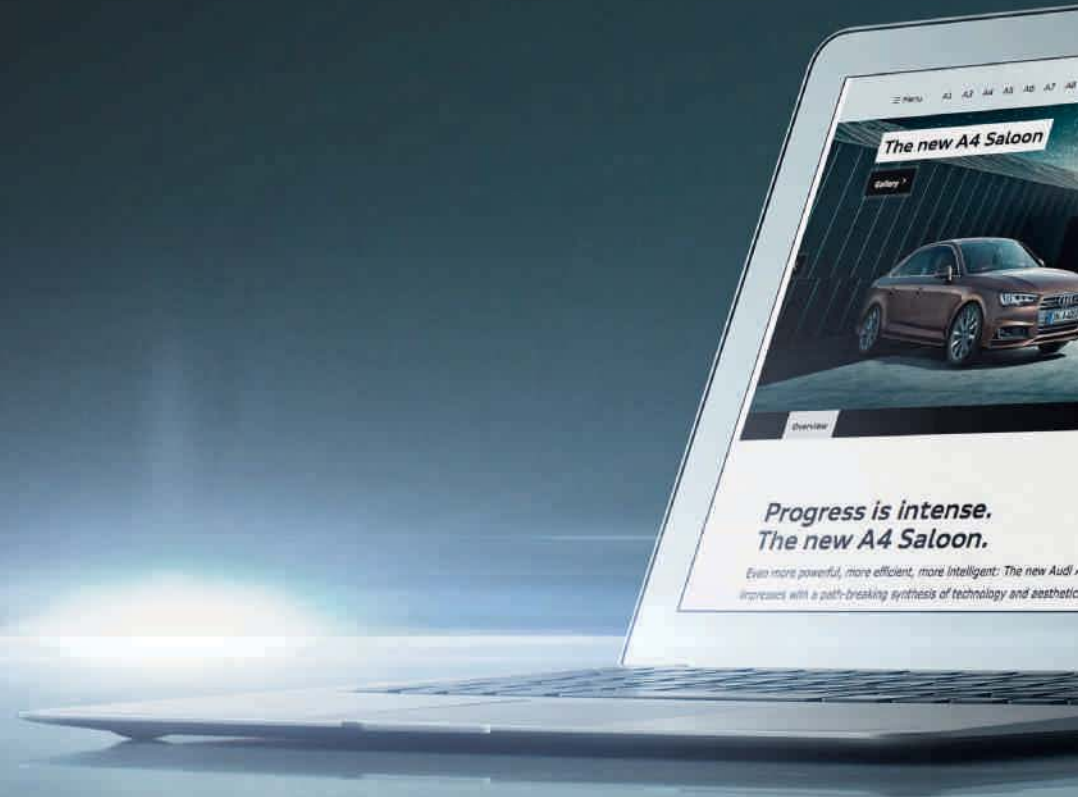



| Model  | Audi A4 1.4 TFSI<br>(110 kW)  | Audi A4 2.0 TFSI<br>(185 kW)  | Audi A4 2.0 TFSI quattro<br>(185 kW)  |                    | Audi A4 2.0 TDI<br>(110 kW)   |              |              |
|--|---|---|---|--------------------|---|--------------|--------------|
| Engine type  | 4-cylinder inline petrol engine with direct fuel injection, turbocharging and Audi valvelift system | 4-cylinder inline petrol engine with direct fuel injection, turbocharging and Audi valvelift system | 4-cylinder inline petrol engine with direct fuel injection, turbocharging and Audi valvelift system |                    | 4-cylinder inline diesel engine with common rail injection system and turbocharging |              |              |
| Displacement in cc (valves per cylinder)                         | 1,395 (4)   | 1,984 (4)   | 1,984 (4)   |                    | 1,968 (4)   |              |              |
| Max. output <sup>1</sup> in kW at rpm                            | 110/5,000–6,000   | 185/5,000–6,000   | 185/5,000–6,000   |                    | 110/3,250–4,200   |              |              |
| Max. torque in Nm at rpm   | 250/1,500–3,500   | 370/1,600–4,500   | 370/1,600–4,500   |                    | 320/1,500–3,250   |              |              |
| <b>Power transmission</b>  |   |   |   |                    |   |              |              |
| Drive type   | Front-wheel drive   | Front-wheel drive   | quattro® permanent all-wheel drive  |                    | Front-wheel drive   |              |              |
| Transmission type  | [7-speed S tronic]  | [7-speed S tronic]  | [7-speed S tronic]  |                    | 6-speed manual transmission<br>[7-speed S tronic]                                   |              |              |
| <b>Weights/capacities</b>  |   |   |   |                    |   |              |              |
|  | <b>Saloon</b>   | <b>Saloon</b>   | <b>Saloon</b>   | <b>Avant</b>       | <b>Saloon</b>   | <b>Avant</b> | <b>Avant</b> |
| Unladen weight <sup>2</sup> in kg                                | [1,450]   | [1,505]   | [1,585]   | [1,615]            | 1,505   | [1,540]      | 1,550        |
| Gross vehicle weight in kg                                       | [1,945]   | [2,000]   | [2,080]   | [2,130]            | 2,030   | [2,065]      | 2,095        |
| Roof load/nose weight in kg                                      | [90/80]   | [90/80]   | [90/80]   | [90/80]            | 90/80   | [90/80]      | 90/80        |
| Trailer load limit <sup>3</sup> in kg<br>unbraked                | [720]   | [750]   | [750]   | [750]              | 750   | [750]        | 750          |
| 12 % gradient  | [1,500]   | [1,700]   | [1,700]   | [1,700]            | 1,700   | [1,700]      | 1,700        |
| 8 % gradient   | [1,700]   | [1,900]   | [1,900]   | [1,900]            | 1,900   | [1,900]      | 1,900        |
| Fuel tank capacity, approx. in l                                 | [54]  | [54]  | [58]  | [58]               | 40/54*  | [40/54*]     | 40/54*       |
| <b>Performance/consumption<sup>4</sup></b>                       |   |   |   |                    |   |              |              |
| Top speed in km/h  | [210] <sup>8</sup>  | [250] <sup>8</sup>  | [250] <sup>8</sup>  | [250] <sup>8</sup> | 221   | [219]        | 215          |
| Acceleration 0–100 km/h in s                                     | [8.5]   | [6.3]   | [5.8]   | [6.0]              | 8.9   | [8.7]        | 9.2          |
| Fuel grade   | Sulphur-free super RON 95 <sup>5</sup>  |   | Sulphur-free super RON 95 <sup>5</sup>  |                    | Sulphur-free diesel <sup>10</sup>   |              |              |
| Fuel consumption <sup>4, 6, 7</sup> in l/100 km<br>urban         | [7.1–6.4 <sup>9</sup> ]   | [7.4]   | [7.9–7.7]   | [7.9–7.7]          | 5.0–4.6   | [5.1–4.8]    | 5.1–4.8      |
| extra-urban  | [4.7–4.1 <sup>9</sup> ]   | [5.0–4.7]   | [5.4–5.0]   | [5.5–5.1]          | 3.9–3.4   | [3.9–3.6]    | 4.0–3.6      |
| combined   | [5.6–4.9 <sup>9</sup> ]   | [5.9–5.7]   | [6.3–5.9]   | [6.4–6.1]          | 4.2–3.8   | [4.3–4.0]    | 4.3–4.0      |
| CO <sub>2</sub> emissions <sup>4, 6, 7</sup> in g/km<br>combined | [129–114 <sup>9</sup> ]   | [137–129]   | [144–136]   | [147–139]          | 111–99  | [112–104]    | 116–104      |
| Emission standard  | [EU6]   | [EU6]   | [EU6]   | [EU6]              | EU6   | [EU6]        | EU6          |

| Model   | Audi A4 2.0 TDI (140 kW)  |              | Audi A4 3.0 TDI quattro (200 kW)                                     |                    | Audi A4 2.0 TFSI ultra (140 kW)   |                          | Audi A4 2.0 TDI ultra (110 kW)  |                    |                  |
|---|---|--------------|--|--------------------|---|--------------------------|---|--------------------|------------------|
| Engine type   | 4-cylinder inline diesel engine with common rail injection system and turbocharging |              | V6 diesel engine with common rail injection system and turbocharging |                    | 4-cylinder inline petrol engine with direct fuel injection, turbocharging and Audi valvelift system |                          | 4-cylinder inline diesel engine with common rail injection system and turbocharging |                    |                  |
| Displacement in cc (valves per cylinder)                    | 1,968 (4)   |              | 2,967 (4)  |                    | 1,984 (4)   |                          | 1,968 (4)   |                    |                  |
| Max. output <sup>1</sup> in kW at rpm                       | 140/3,800–4,200   |              | 200/3,250–4,250  |                    | 140/4,200–6,000   |                          | 110/3,250–4,200   |                    |                  |
| Max. torque in Nm at rpm                                    | 400/1,750–3,000   |              | 600/1,500–3,000  |                    | 320/1,450–4,200   |                          | 320/1,500–3,250   |                    |                  |
| <b>Power transmission</b>                                   |   |              |  |                    |   |                          |   |                    |                  |
| Drive type  | Front-wheel drive   |              | quattro® permanent all-wheel drive                                   |                    | Front-wheel drive   |                          | Front-wheel drive   |                    |                  |
| Transmission type   | [7-speed S tronic]  |              | [8-speed tiptronic]  |                    | [7-speed S tronic]  |                          | 6-speed manual transmission [7-speed S tronic]                                      |                    |                  |
| <b>Weights/capacities</b>                                   |   |              |  |                    |   |                          |   |                    |                  |
|   | <b>Saloon</b>   | <b>Avant</b> | <b>Saloon</b>  | <b>Avant</b>       | <b>Saloon</b>   | <b>Avant</b>             | <b>Saloon</b>   | <b>Avant</b>       | <b>Avant</b>     |
| Unladen weight <sup>2</sup> in kg                           | [1,555]   | [1,605]      | [1,735]  | [1,770]            | [1,480]   | [1,535]                  | 1,505   | [1,545]            | 1,555            |
| Gross vehicle weight in kg                                  | [2,075]   | [2,145]      | [2,230]  | [2,285]            | [1,985]   | [2,060]                  | 2,030   | [2,070]            | 2,100            |
| Roof load/nose weight in kg                                 | [90/80]   | [90/80]      | [90/80]  | [90/80]            | [90/80]   | [90/80]                  | 90/80   | [90/80]            | 90/80            |
| Trailer load limit <sup>3</sup> in kg unbraked              | [750]   | [750]        | [750]  | [750]              | [740]   | [750]                    | 750   | [750]              | 750              |
| 12 % gradient   | [1,700]   | [1,700]      | [1,900]  | [1,900]            | [1,500]   | [1,500]                  | 1,400   | [1,400]            | 1,400            |
| 8 % gradient  | [1,900]   | [1,900]      | [2,100]  | [2,100]            | [1,700]   | [1,700]                  | 1,600   | [1,600]            | 1,600            |
| Fuel tank capacity, approx. in l                            | [40/54*]  | [40/54*]     | [58]   | [58]               | [54]  | [54]                     | 40/54*  | [40/54*]           | 40/54*           |
| <b>Performance/consumption<sup>4</sup></b>                  |   |              |  |                    |   |                          |   |                    |                  |
| Top speed in km/h   | [237]   | [231]        | [250] <sup>8</sup>   | [250] <sup>8</sup> | [240] <sup>8,12</sup>   | [238] <sup>8,12</sup>    | 210 <sup>8</sup>  | [210] <sup>8</sup> | 210 <sup>8</sup> |
| Acceleration 0–100 km/h in s                                | [7.7]   | [7.9]        | [5.3]  | [5.4]              | [7.3]   | [7.5]                    | 8.9   | [8.7]              | 9.2              |
| Fuel grade  | Sulphur-free diesel <sup>10</sup>   |              | Sulphur-free diesel <sup>10</sup>                                    |                    | Sulphur-free super RON 95 <sup>7</sup>  |                          | Sulphur-free diesel <sup>10</sup>   |                    |                  |
| Fuel consumption <sup>4,6,7</sup> in l/100 km urban         | [5.0–4.8]   | [5.0–4.9]    | [5.6–5.4]  | [5.8–5.6]          | [6.6–6.2 <sup>13</sup> ]  | [6.8–6.4 <sup>13</sup> ] | 4.5–4.4   | [4.7–4.6]          | 4.7–4.5          |
| extra-urban   | [3.9–3.7]   | [4.1–3.8]    | [4.9–4.6]  | [5.1–4.8]          | [4.7–4.0 <sup>13</sup> ]  | [4.9–4.3 <sup>13</sup> ] | 3.4–3.3   | [3.5–3.4]          | 3.6–3.4          |
| combined  | [4.3–4.1]   | [4.4–4.2]    | [5.2–4.9]  | [5.4–5.1]          | [5.4–4.8 <sup>13</sup> ]  | [5.6–5.0 <sup>13</sup> ] | 3.8–3.7   | [3.9–3.8]          | 4.0–3.8          |
| CO <sub>2</sub> emissions <sup>4,6,7</sup> in g/km combined | [113–107]   | [116–109]    | [137–129]  | [142–134]          | [122–109 <sup>13</sup> ]  | [128–114 <sup>13</sup> ] | 99–95   | [101–99]           | 104–99           |
| Emission standard   | [EU6]   | [EU6]        | [EU6]  | [EU6]              | [EU6]   | [EU6]                    | EU6   | [EU6]              | EU6              |

### **Audi A4 Saloon or A4 Avant 2.0 TFSI ultra (140 kW from 109 g and 114 g CO<sub>2</sub>/km)**

The A4 2.0 TFSI ultra model is available with all equipment without any restrictions.

### **Audi A4 Saloon 2.0 TDI ultra (110 kW from 95 g CO<sub>2</sub>/km for manual transmission and from 99 g CO<sub>2</sub>/km for automatic) or A4 Avant 2.0 TDI ultra (110 kW from 99 g CO<sub>2</sub>/km)**

These vehicles represent extra efficiency Audi models in which the balance between power and consumption has been improved even further. These Audi models are characterised by reduced consumption and CO<sub>2</sub> emissions when compared with standard models. This effect has been achieved by modifications to the vehicle.

#### **The A4 Saloon and A4 Avant 2.0 TDI ultra models (110 kW) are equipped with the following as standard:**

- 6-speed manual transmission with improved transmission ratio
- also available with 7-speed S tronic automatic transmission
- driver information system with gear change and efficiency displays; provides gear-changing and fuel-saving tips to help the driver adopt a fuel-efficient driving style
- swivelling radiator grille to optimise heat-up behaviour and aerodynamics
- tyres with improved rolling resistance to allow fuel to be saved
- improved ride height (thanks to sport suspension) and various vehicle components for low drag coefficient

**As standard the A4 Saloon and the A4 Avant 2.0 TDI ultra (110 kW) are equipped with forged lightweight wheels with full wheel covers, size 7 J x 16 with 205/60 R 16 tyres.**

#### **The following wheel options are also available:**

- forged aluminium wheels in 10-spoke design, size 7.5 J x 17 with 225/50 R 17 tyres<sup>11</sup>
- cast aluminium wheels in 5-arm star design, size 7.5 J x 17 with 225/50 R 17 tyres<sup>11</sup>
- cast aluminium wheels in 5-parallel-spoke design, size 7.5 J x 17 with 225/50 R 17 tyres<sup>11</sup>
- cast aluminium wheels in 5-arm aero design, contrasting grey, partly polished, size 7.5 J x 17 with 225/50 R 17 tyres<sup>11</sup>
- cast aluminium wheels in 5-spoke Y design, size 7.5 J x 17 with 225/50 R 17 tyres<sup>11</sup>
- cast aluminium wheels in 10-spoke crystal design, size 7.5 J x 17 with 225/50 R 17 tyres<sup>11</sup>
- forged aluminium wheels in 10-spoke design, size 7.5 J x 17 with 225/50 R 17 tyres<sup>11</sup>

#### **The following equipment is not available for the A4 Saloon or A4 Avant 2.0 TDI ultra (110 kW):**

- S line sport package
- comfort suspension with damper control
- auxiliary heating

### **Explanatory notes**













- <sup>1</sup> The figure given was calculated using the specified measuring procedure (current version of UN-R 85).
- <sup>2</sup> Unladen vehicle weight includes driver (75 kg) and fuel tank 90% full, calculated in accordance with the current version of Reg. (EU) 1230/2012. Optional equipment may increase the car's unladen weight and drag coefficient, whereupon the possible payload limit and the top speed will be reduced accordingly.
- <sup>3</sup> The engine's power output always decreases with increasing altitude. At 1,000 m above sea level, and for every additional 1,000 m, deduct 10% from the weight of the outfit (trailer load limit + gross weight of the towing vehicle). Figure for trailer load limit applies to factory-fitted trailer towing hitch. If using the vehicle with a trailer towing hitch for commercial purposes, a digital tachograph may be required under certain conditions.
- <sup>4</sup> Fuel consumption and CO<sub>2</sub> emission figures given in ranges depend on the tyre/wheel sets used.
- <sup>5</sup> We recommend using sulphur-free super unleaded RON 95 fuel complying with DIN EN 228. If this is not available, use sulphur-free regular unleaded RON 91 fuel complying with DIN EN 228; power output will be slightly reduced. Unleaded RON 95 fuel with a maximum ethanol content of 10% (E10) can generally be used. Fuel consumption details refer to operation with RON 95 fuel complying with 692/2008/EC.
- <sup>6</sup> The figures given were calculated using the specified measuring procedures. The figures do not refer to one individual vehicle and do not form part of any offer, but rather should be used purely for purposes of comparison between the different vehicle models.
- <sup>7</sup> A vehicle's fuel consumption and CO<sub>2</sub> emissions do not just depend on how efficiently the vehicle uses the fuel, but are also influenced by driving behaviour and other non-technical factors. CO<sub>2</sub> is the greenhouse gas primarily responsible for global warming.
- <sup>8</sup> Regulated.
- <sup>9</sup> In conjunction with low rolling-resistance tyres.
- <sup>10</sup> We recommend using sulphur-free diesel complying with DIN EN 590. If this is not available, use diesel complying with DIN EN 590.
- <sup>11</sup> You will find specifications on the technical characteristics of tyres on page 71.
- <sup>12</sup> In conjunction with low rolling-resistance tyres, the maximum permissible speed is 210 km/h.
- <sup>13</sup> In conjunction with low rolling-resistance tyres and a maximum permissible speed of 210 km/h.
- <sup>14</sup> Please note the special information relating to wheels on page 71.

### Important note

**Special information about the wheels:** Wheels with gloss turned finish as well as polished or partly polished aluminium wheels must not be used in wintry road conditions. For manufacturing reasons, the rim surface does not have sufficient corrosion protection for such use and can be damaged permanently by road salt or similar.

### Classifications of tyre parameters

The table shows the range of fuel efficiency, wet grip and exterior noise emission classes for the different tyre sizes of the Audi A4 Saloon and the Audi A4 Avant.

|              | Tyre size   | Fuel efficiency class | Wet grip class | Exterior noise emission class   |
|--------------|-------------|-----------------------|----------------|---|
| Summer tyres | 205/60 R 16 | E-C                   | B-A            | 71-70    |
|              | 225/50 R 17 | F-C                   | C-A            | 73-67  -  |
|              | 245/40 R 18 | F-C                   | B-A            | 72-68  -  |
|              | 245/35 R 19 | E                     | B              | 67   |
| Winter tyres | 205/60 R 16 | E                     | C              | 67   |
|              | 225/50 R 17 | F-E                   | E-C            | 72-68  -  |
|              | 225/45 R 18 | E                     | C              | 72-69  -  |
|              | 245/40 R 18 | F-E                   | E-B            | 72-68  -  |

It is not possible to order a specific tyre.

Ask your Audi partner about the range of tyres available in your country.

Equipment for the Audi A4 Saloon illustrated (p. 2-43):

Paint finish: Argus brown, metallic

Wheels: cast aluminium wheels in 10-spoke dynamic design, partly polished<sup>14</sup>

Seats/seat upholstery: sport seats, front, in fine Nappa leather, cedar brown with contrasting stitching and piping in granite grey

Inlays: oak, natural grey

Other equipment: Audi design selection, S line exterior package

Equipment for the Audi A4 Avant illustrated (p. 2-43):

Paint finish: Daytona grey, pearl effect

Wheels: cast aluminium wheels in 5-twin-spoke star design (S design)

Seats/seat upholstery: sport seats, front, in fine Nappa leather, rotor grey with contrasting stitching in rock grey

Inlays: matt brushed aluminium

Other equipment: S line sport package, S line exterior package

### Audi A4 Saloon

Dimensions in mm

Dimensions are for vehicle at unladen weight. Luggage capacity: 480/965 l

(second value with rear seat backrest folded down and vehicle loaded up to the rear parcel shelf). Turning circle approx. 11.6 m.

\* Maximum headroom. \*\* Elbow room width. \*\*\* Shoulder room width.

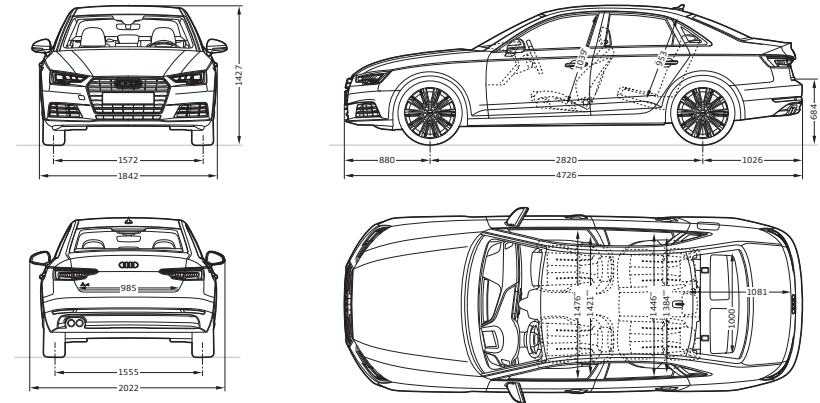

### Audi A4 Avant

Dimensions in mm

Dimensions are for vehicle at unladen weight. Luggage capacity 505/1,510 l

(second value with rear set backrest folded down and vehicle loaded up to roof height). Turning circle approx. 11.6 m.

\* Maximum headroom. \*\* Elbow room width. \*\*\* Shoulder room width.

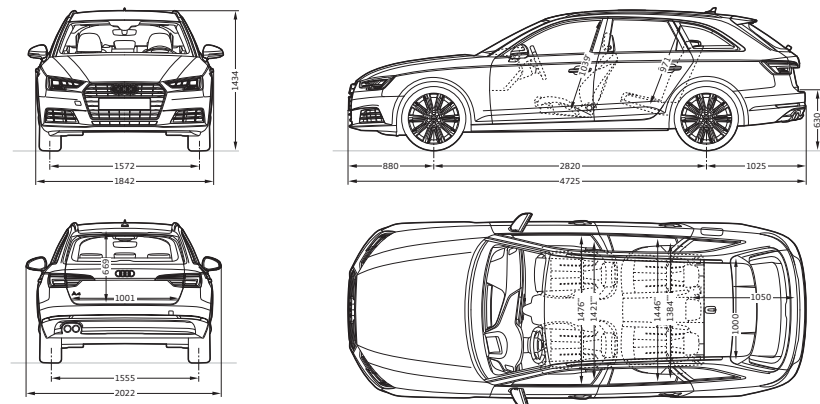

|   | A4 | A4 design | A4 sport |
|---|----|-----------|----------|
| <b>Lines and packages</b>                             |    |           |          |
| Audi design selection                                 | –  | ■         | –        |
| S line sport package                                  | –  | –         | ■        |
| S line exterior package                               | ■  | ■         | ■        |
| <b>Solid paint finishes</b>                           |    |           |          |
| Ibis white  | □  | □         | □        |
| Brilliant black                                       | □  | □         | □        |
| <b>Metallic paint finishes</b>                        |    |           |          |
| Glacier white, metallic                               | ■  | ■         | ■        |
| Floret silver, metallic                               | ■  | ■         | ■        |
| Cuvée silver, metallic                                | ■  | ■         | ■        |
| Manhattan grey, metallic                              | ■  | ■         | ■        |
| Monsoon grey, metallic                                | ■  | ■         | ■        |
| Gotland green, metallic <sup>1</sup>                  | ■  | ■         | ■        |
| Argus brown, metallic                                 | ■  | ■         | ■        |
| Moonlight blue, metallic                              | ■  | ■         | ■        |
| Scuba blue, metallic                                  | ■  | ■         | ■        |
| Mythos black, metallic                                | ■  | ■         | ■        |
| Matador red, metallic <sup>1</sup>                    | ■  | ■         | ■        |
| Tango red, metallic                                   | ■  | ■         | ■        |
| <b>Pearl effect paint finish</b>                      |    |           |          |
| Daytona grey, pearl effect <sup>2</sup>               | ■  | ■         | ■        |
| <b>Customised paint finishes</b>                      |    |           |          |
| Audi exclusive customised paint finishes <sup>3</sup> | ■  | ■         | ■        |
| <b>Wheels/tyres</b>                                   |    |           |          |
| 16" forged lightweight wheel with full wheel cover    | □  | –         | –        |
| 16" cast aluminium wheels in 5-arm design             | ■  | –         | –        |

|  | A4             | A4 design      | A4 sport |
|--|----------------|----------------|----------|
| 16" cast aluminium wheels in 5-arm facet design  | ■              | –              | –        |
| 17" cast aluminium wheels in 5-arm aero design, contrasting grey, partly polished <sup>4</sup>               | ■              | ■              | ■        |
| 17" cast aluminium wheels in 5-spoke Y design  | –              | –              | □        |
| 17" cast aluminium wheels in 5-parallel-spoke design   | ■              | ■              | ■        |
| 17" cast aluminium wheels in 5-arm star design   | ■              | ■              | ■        |
| 17" cast aluminium wheels in 10-spoke crystal design   | –              | □              | –        |
| 17" forged aluminium wheels in 10-spoke design   | □ <sup>5</sup> | ■              | ■        |
| 18" cast aluminium wheels in 5-spoke dynamic design, contrasting grey, partly polished <sup>4</sup>          | ■              | ■              | ■        |
| 18" Audi Sport cast aluminium wheels in 5-twin-spoke design with RS logo <sup>3</sup>                        | ■              | ■              | ■        |
| 18" cast aluminium wheels in 5-twin-spoke design, contrasting grey, partly polished <sup>4</sup>             | ■              | ■              | ■        |
| 18" Audi Sport cast aluminium wheels in 5-arm pylon design in matt black, gloss turned finish <sup>3,4</sup> | ■              | ■              | ■        |
| 18" cast aluminium wheels in 10-spoke dynamic design, partly polished <sup>4</sup>                           | ■              | ■ <sup>6</sup> | ■        |
| 18" cast aluminium wheels in 10-spoke V design   | ■              | ■              | ■        |
| 18" Audi Sport cast aluminium wheels in 10-Y-spoke design <sup>3</sup>                                       | ■              | ■              | ■        |

|  | A4 | A4 design | A4 sport       |
|--|----|-----------|----------------|
| 18" cast aluminium wheels in 5-twin-spoke star design (S design)   | –  | –         | ■ <sup>7</sup> |
| 19" Audi Sport cast aluminium wheels in 5-V-spoke design in matt titanium look, gloss turned finish <sup>4</sup> , with RS logo <sup>3</sup> | ■  | ■         | ■              |
| 19" Audi Sport cast aluminium wheels in 10-V-spoke design <sup>3</sup>   | ■  | ■         | ■              |
| 16" forged aluminium winter wheels with full wheel cover   | ■  | ■         | ■              |
| 17" cast aluminium winter wheels in 5-parallel-spoke design  | ■  | ■         | ■              |
| 18" cast aluminium winter wheels in 10-spoke V design  | ■  | ■         | ■              |
| 18" cast aluminium winter wheels in 10-spoke V design  | ■  | ■         | ■              |
| 18" cast aluminium winter wheels in 5-twin-spoke star design (S design)  | –  | –         | ■ <sup>7</sup> |
| Anti-theft wheel bolts   | ■  | ■         | ■              |
| Tyre repair kit  | □  | □         | □              |
| Spare wheel, space-saving  | ■  | ■         | ■              |
| Tyre pressure loss indicator   | □  | □         | □              |
| Vehicle tool kit   | □  | □         | □              |
| Vehicle jack   | □  | □         | □              |
| <b>Seats</b>   |    |           |                |
| Standard seats, front  | □  | □         | –              |
| Sport seats, front   | ■  | ■         | □              |
| <b>Seat upholstery for standard seats, front</b>   |    |           |                |
| Index cloth, black   | □  | –         | –              |
| Index cloth, rock grey   | □  | –         | –              |
| Concept cloth, black   | –  | □         | –              |

|  | A4 | A4 design      | A4 sport       |
|--|----|----------------|----------------|
| Concept cloth, rock grey   | –  | □              | –              |
| Fazit cloth/leather, black                                       | –  | ■ <sup>6</sup> | –              |
| Fazit cloth/leather, rock grey                                   | –  | ■ <sup>6</sup> | –              |
| Leather/artificial leather, black                                | ■  | ■              | –              |
| Leather/artificial leather, nougat brown                         | ■  | ■              | –              |
| Leather/artificial leather, rock grey                            | ■  | ■              | –              |
| Leather/artificial leather, Atlas beige                          | ■  | ■              | –              |
| Milano leather, black  | ■  | ■              | –              |
| Milano leather, nougat brown                                     | ■  | ■              | –              |
| Milano leather, rock grey  | ■  | ■              | –              |
| Milano leather, Atlas beige                                      | ■  | ■              | –              |
| <b>Seat upholstery for sport seats, front</b>                    |    |                |                |
| System cloth, black  | –  | –              | □              |
| System cloth, black-red  | –  | –              | □              |
| Leather/artificial leather, black                                | ■  | ■              | ■              |
| Leather/artificial leather, nougat brown                         | ■  | ■              | ■              |
| Leather/artificial leather, rock grey                            | ■  | ■              | ■              |
| Perforated leather/artificial leather, black <sup>8</sup>        | ■  | ■              | ■              |
| Perforated leather/artificial leather, nougat brown <sup>8</sup> | ■  | ■              | ■              |
| Perforated leather/artificial leather, rock grey <sup>8</sup>    | ■  | ■              | ■              |
| Alcantara/leather, black   | ■  | ■              | ■              |
| Alcantara/leather, rock grey                                     | ■  | ■              | ■              |
| Alcantara/leather, rock grey with contrasting stitching          | –  | ■ <sup>9</sup> | –              |
| Alcantara/leather, rotor grey with contrasting stitching         | –  | –              | ■ <sup>7</sup> |

Explanation of <sup>1</sup> to <sup>19</sup> on page 75.



|   | A4 | A4 design      | A4 sport       |
|---|----|----------------|----------------|
| Alcantara/leather, black with contrasting stitching                                       | –  | –              | ■ <sup>7</sup> |
| Alcantara/leather, Atlas beige with contrasting stitching                                 | –  | ■ <sup>9</sup> | –              |
| Milano leather, black   | ■  | ■              | ■              |
| Milano leather, nougat brown  | ■  | ■              | ■              |
| Milano leather, rock grey   | ■  | ■              | ■              |
| Milano leather, Atlas beige   | ■  | ■              | ■              |
| Perforated Milano leather, black <sup>8</sup>   | ■  | ■              | ■              |
| Fine Nappa leather, rock grey with contrasting and piping                                 | –  | ■ <sup>9</sup> | –              |
| Fine Nappa leather, Atlas beige with contrasting and piping                               | –  | ■ <sup>9</sup> | –              |
| Fine Nappa leather, cedar brown with contrasting and piping                               | –  | ■ <sup>9</sup> | –              |
| Fine Nappa leather, rotor grey with contrasting stitching                                 | –  | –              | ■ <sup>7</sup> |
| Leder Feinnappa schwarz mit Kontrastnähten  | –  | –              | ■ <sup>7</sup> |
| Audi exclusive leather upholstery and trim <sup>3</sup>                                   | –  | ■              | ■              |
| <b>Leather packages</b>   |    |                |                |
| Interior elements in artificial leather   | ■  | ■              | ■              |
| Audi exclusive leather upholstery and trim (package 1) in fine Nappa leather <sup>3</sup> | ■  | ■              | ■              |
| Audi exclusive extended leather upholstery and trim <sup>3, 10</sup>                      | ■  | ■              | ■              |
| Audi exclusive seat attachments in matching colour <sup>3, 10</sup>                       | ■  | ■              | ■              |
| <b>Seating comfort</b>  |    |                |                |
| Front seats, manually adjustable  | □  | □              | □              |
| Driver seat, electrically adjustable  | ■  | ■              | ■              |
| Front seats, electrically adjustable  | ■  | ■              | ■              |

|   | A4 | A4 design      | A4 sport       |
|---|----|----------------|----------------|
| Front seats, electrically adjustable, including memory function for the driver seat | ■  | ■              | ■              |
| 4-way lumbar support for the front seats  | ■  | ■              | ■              |
| Variable head restraints for front seats  | ■  | ■              | ■              |
| Comfort centre armrest, front   | ■  | ■              | ■              |
| Centre armrest, front   | □  | □              | □              |
| Seat heating, front   | ■  | ■              | ■              |
| Seat heating, front and rear  | ■  | ■              | ■              |
| Seat ventilation, front   | ■  | ■              | ■              |
| <b>Rear seats</b>   |    |                |                |
| Rear seat backrest, folding <sup>11</sup>   | ■  | ■              | ■              |
| <b>Headlinings</b>  |    |                |                |
| Headlining in cloth, black  | ■  | ■              | ■              |
| Headlining in cloth   | □  | □              | □              |
| <b>Inlays</b>   |    |                |                |
| Diamond paint finish, silver grey   | □  | –              | –              |
| Aluminium ellipse   | ■  | □              | □              |
| Matt brushed aluminium  | –  | –              | □ <sup>7</sup> |
| Aluminium trimaran  | –  | □ <sup>9</sup> | –              |
| Walnut, dark brown <sup>1</sup>   | ■  | ■              | ■              |
| Oak, natural grey   | ■  | ■              | ■              |
| Piano finish, black <sup>3</sup>  | ■  | ■              | ■              |
| Audi exclusive wood inlays <sup>3</sup>   | ■  | ■              | ■              |
| <b>Headlights</b>   |    |                |                |
| Audi Matrix LED headlights incl. LED rear lights with dynamic indicators            | ■  | ■              | ■              |

|  | A4              | A4 design      | A4 sport |
|--|-----------------|----------------|----------|
| LED headlights incl. LED rear lights with dynamic indicators                 | ■               | ■              | ■        |
| Xenon plus   | □               | □              | □        |
| Headlight cleaning system  | ■               | ■              | ■        |
| High-beam assist <sup>12</sup>   | ■               | ■              | ■        |
| Light/rain sensor  | ■               | ■              | ■        |
| Rear lights  | □               | □              | □        |
| <b>Interior lighting</b>   |                 |                |          |
| Ambient lighting   | ■               | ■ <sup>6</sup> | ■        |
| Lighting package   | ■               | ■              | ■        |
| Interior lighting  | □               | □              | □        |
| <b>Exterior design</b>   |                 |                |          |
| Exhaust tailpipes  | □               | □              | □        |
| Model name/logo  | □               | □              | □        |
| Roof rails, black <sup>13</sup>  | □               | ■              | ■        |
| Roof rails, anodised <sup>13</sup>   | ■ <sup>14</sup> | □              | □        |
| Roof edge spoiler <sup>13</sup>  | ■               | ■              | ■        |
| Trim strips, black   | □               | –              | –        |
| Gloss package  | ■               | □              | □        |
| Audi exclusive titanium black gloss package <sup>1, 3</sup>                  | ■               | ■              | ■        |
| <b>Interior design</b>   |                 |                |          |
| Floor mats, front  | □               | □              | □        |
| Floor mats, front and rear   | ■               | ■              | ■        |
| Audi exclusive floor mats <sup>3</sup>                                       | ■               | ■              | ■        |
| Door sill trims with aluminium inlays  | □               | □              | □        |
| Door sill trims with aluminium inlays and S emblem, illuminated <sup>2</sup> | ■               | ■              | ■        |

|  | A4 | A4 design      | A4 sport |
|--|----|----------------|----------|
| Door sill trims with aluminium inlays, illuminated   | –  | □ <sup>9</sup> | –        |
| Aluminium look in the interior   | □  | □              | □        |
| <b>Steering wheels/controls</b>  |    |                |          |
| Leather steering wheel in 3-spoke design with multifunction plus   | ■  | ■ <sup>6</sup> | ■        |
| Leather steering wheel in 3-spoke design with multifunction  | ■  | □              | □        |
| Sport contour leather steering wheel in 3-spoke design, flattened at the bottom, with multifunction plus   | –  | ■              | ■        |
| Steering wheel in 3-spoke design with multifunction  | □  | –              | –        |
| Audi exclusive leather controls <sup>3</sup>   | ■  | ■              | ■        |
| Audi exclusive controls in Alcantara/leather combination <sup>3</sup>  | ■  | ■              | ■        |
| <b>Mirrors</b>   |    |                |          |
| Exterior mirrors with integrated LED indicator   | □  | □              | □        |
| Exterior mirrors, additionally heated, including heated washer jets  | ■  | ■              | ■        |
| Exterior mirrors, additionally electrically folding including automatic kerb-side function for the exterior mirror on the passenger side (also available with memory function) | ■  | ■              | ■        |
| Exterior mirrors, additionally automatically dimming on both sides (also available with memory function)   | ■  | ■              | ■        |
| Interior mirror, dimming   | □  | □              | □        |
| Frameless interior mirror, automatically dimming   | ■  | ■              | ■        |

|   | A4 | A4 design | A4 sport |
|---|----|-----------|----------|
| <b>Roof systems</b>   |    |           |          |
| Slide-and-tilt glass sunroof <sup>15</sup>  | ■  | ■         | ■        |
| Panoramic glass sunroof <sup>13</sup>   | ■  | ■         | ■        |
| <b>Glazing</b>  |    |           |          |
| Heat-insulating glass   | □  | □         | □        |
| Privacy glazing (dark-tinted windows) and door windows, front, with acoustic glazing  | ■  | ■         | ■        |
| Acoustic glazing for door windows, front  | ■  | ■         | ■        |
| Heated windscreen   | ■  | ■         | ■        |
| Climate-controlled comfort/acoustic windscreen, heated wirelessly <sup>1</sup>  | ■  | ■         | ■        |
| Sunblind for rear door windows  | ■  | ■         | ■        |
| Sun visors  | □  | □         | □        |
| Sun visors, movable   | ■  | ■         | ■        |
| <b>Climate control</b>  |    |           |          |
| Automatic air conditioning  | □  | □         | □        |
| 3-zone deluxe automatic air conditioning  | ■  | ■         | ■        |
| Auxiliary heating/ventilation   | ■  | ■         | ■        |
| <b>Closing systems</b>  |    |           |          |
| Garage door opener (HomeLink)   | ■  | ■         | ■        |
| Anti-theft alarm  | ■  | ■         | ■        |
| Preparation for tracking system <sup>16</sup>   | ■  | ■         | ■        |
| Convenience key, including sensor-controlled release of the luggage compartment lid <sup>15</sup>   | ■  | ■         | ■        |
| Convenience key including sensor-controlled release of the luggage compartment lid, including luggage compartment lid, electrically opening and closing <sup>13</sup> | ■  | ■         | ■        |

|   | A4 | A4 design | A4 sport |
|---|----|-----------|----------|
| Luggage compartment lid, automatically opening <sup>15</sup>            | □  | □         | □        |
| Luggage compartment lid, electrically opening and closing <sup>13</sup> | ■  | ■         | ■        |
| Electric luggage compartment cover <sup>13</sup>                        | □  | □         | □        |
| Electronic immobiliser  | □  | □         | □        |
| <b>Storage/transport</b>  |    |           |          |
| Storage compartments  | □  | □         | □        |
| Cigarette lighter and ashtrays  | ■  | ■         | ■        |
| Rail system with load-securing kit <sup>13</sup>                        | ■  | ■         | ■        |
| Partition net <sup>13</sup>   | □  | □         | □        |
| Reversible luggage compartment floor <sup>13</sup>                      | □  | □         | □        |
| Variable folding luggage compartment mat                                | ■  | ■         | ■        |
| Trailer towing hitch  | ■  | ■         | ■        |
| Provision for trailer towing hitch                                      | ■  | ■         | ■        |
| Storage and luggage compartment package                                 | ■  | ■         | ■        |
| <b>Instrument clusters/ display instruments</b>                         |    |           |          |
| Driver information system   | □  | □         | □        |
| Driver information system with colour display                           | ■  | ■         | ■        |
| Audi virtual cockpit  | ■  | ■         | ■        |
| Head-up display   | ■  | ■         | ■        |
| Attention assist  | □  | □         | □        |
| <b>Radio/navigation systems</b>   |    |           |          |
| MMI® radio plus   | □  | □         | □        |
| Connectivity package <sup>1</sup>                                       | ■  | ■         | ■        |
| MMI® navigation   | ■  | ■         | ■        |
| MMI® navigation plus with MMI touch incl. MMI search                    | ■  | ■         | ■        |

|   | A4 | A4 design | A4 sport |
|---|----|-----------|----------|
| <b>Audio/video sources</b>                                  |    |           |          |
| Preparation for Rear Seat Entertainment                     | ■  | ■         | ■        |
| Audi tablet including Rear Seat Entertainment <sup>17</sup> | ■  | ■         | ■        |
| Digital Audio Broadcasting                                  | ■  | ■         | ■        |
| Digital TV reception  | ■  | ■         | ■        |
| TV reception and Digital Audio Broadcasting (DAB)           | ■  | ■         | ■        |
| Audi music interface  | ■  | ■         | ■        |
| <b>Sound systems</b>  |    |           |          |
| 8 loudspeakers (passive)                                    | □  | □         | □        |
| Audi sound system   | ■  | ■         | ■        |
| Bang & Olufsen 3D Sound System                              | ■  | ■         | ■        |
| <b>Phone</b>  |    |           |          |
| Bluetooth interface   | □  | □         | □        |
| Audi phone box with wireless charging                       | ■  | ■         | ■        |
| <b>mySmartphone</b>   |    |           |          |
| Audi smartphone interface                                   | ■  | ■         | ■        |
| Access to smartphone voice control <sup>18</sup>            | □  | □         | □        |
| <b>Audi connect</b>   |    |           |          |
| Audi connect  | ■  | ■         | ■        |
| Audi connect emergency call & service                       | ■  | ■         | ■        |
| <b>Assistance systems</b>                                   |    |           |          |
| Programmable speed limiter                                  | ■  | ■         | ■        |
| Cruise control  | ■  | ■         | ■        |
| Hold assist   | ■  | ■         | ■        |

|   | A4 | A4 design | A4 sport |
|---|----|-----------|----------|
| City assistance package                   | ■  | ■         | ■        |
| Audi pre sense basic                      | ■  | ■         | ■        |
| Audi pre sense city                       | ■  | ■         | ■        |
| Audi side assist                          | ■  | ■         | ■        |
| Tour assistance package                   | ■  | ■         | ■        |
| Camera-based recognition of traffic signs | ■  | ■         | ■        |
| Audi active lane assist                   | ■  | ■         | ■        |
| Parking assistance package                | ■  | ■         | ■        |
| Park assist                               | ■  | ■         | ■        |
| Reversing camera                          | ■  | ■         | ■        |
| Parking system, rear                      | ■  | ■         | ■        |
| Parking system plus                       | ■  | ■         | ■        |
| <b>Driving dynamics/brakes</b>            |    |           |          |
| Audi drive select                         | ■  | ■         | ■        |
| quattro®                                  | ■  | ■         | ■        |
| S tronic®                                 | ■  | ■         | ■        |
| tiptronic                                 | ■  | ■         | ■        |
| Dynamic suspension                        | □  | □         | □        |
| Comfort suspension with damper control    | ■  | ■         | ■        |
| Dynamic steering                          | ■  | ■         | ■        |
| Sport suspension                          | ■  | ■         | ■        |
| Sport suspension with damper control      | ■  | ■         | ■        |
| Front-wheel drive                         | □  | □         | □        |
| 6-speed manual transmission               | □  | □         | □        |
| Electromechanical power steering          | □  | □         | □        |
| Brake system                              | □  | □         | □        |
| Disc brakes, front                        | □  | □         | □        |

|  | A4                                  | A4 design                           | A4 sport                            |
|--|-------------------------------------|-------------------------------------|-------------------------------------|
| Electromechanical parking brake                                    | <input type="checkbox"/>            | <input type="checkbox"/>            | <input type="checkbox"/>            |
| <b>Technology/safety</b>   |                                     |                                     |                                     |
| Anti-Slip Regulation (ASR)   | <input type="checkbox"/>            | <input type="checkbox"/>            | <input type="checkbox"/>            |
| Electronic Differential Lock (EDL)                                 | <input type="checkbox"/>            | <input type="checkbox"/>            | <input type="checkbox"/>            |
| Electronic Stabilisation Control (ESC)                             | <input type="checkbox"/>            | <input type="checkbox"/>            | <input type="checkbox"/>            |
| SCR tank (12 l) for TDI models                                     | <input type="checkbox"/>            | <input type="checkbox"/>            | <input type="checkbox"/>            |
| SCR tank (24 l) for TDI models                                     | <input checked="" type="checkbox"/> | <input checked="" type="checkbox"/> | <input checked="" type="checkbox"/> |
| Misfuelling protection   | <input type="checkbox"/>            | <input type="checkbox"/>            | <input type="checkbox"/>            |
| Recuperation   | <input type="checkbox"/>            | <input type="checkbox"/>            | <input type="checkbox"/>            |
| Start-stop system  | <input type="checkbox"/>            | <input type="checkbox"/>            | <input type="checkbox"/>            |
| Audi TDI clean diesel <sup>19</sup>                                | <input type="checkbox"/>            | <input type="checkbox"/>            | <input type="checkbox"/>            |
| Airbags  | <input type="checkbox"/>            | <input type="checkbox"/>            | <input type="checkbox"/>            |
| Side airbags, front, and head airbag system                        | <input type="checkbox"/>            | <input type="checkbox"/>            | <input type="checkbox"/>            |
| Side airbags, rear   | <input checked="" type="checkbox"/> | <input checked="" type="checkbox"/> | <input checked="" type="checkbox"/> |
| Seat belts   | <input type="checkbox"/>            | <input type="checkbox"/>            | <input type="checkbox"/>            |
| Safety steering column   | <input type="checkbox"/>            | <input type="checkbox"/>            | <input type="checkbox"/>            |
| Child-proof locks  | <input type="checkbox"/>            | <input type="checkbox"/>            | <input type="checkbox"/>            |
| ISOFIX child seat mounting for the front-passenger seat            | <input checked="" type="checkbox"/> | <input checked="" type="checkbox"/> | <input checked="" type="checkbox"/> |
| ISOFIX child seat mounting and top tether for the outer rear seats | <input type="checkbox"/>            | <input type="checkbox"/>            | <input type="checkbox"/>            |
| Warning triangle   | <input type="checkbox"/>            | <input type="checkbox"/>            | <input type="checkbox"/>            |
| First-aid kit  | <input type="checkbox"/>            | <input type="checkbox"/>            | <input type="checkbox"/>            |
| <b>Audi Extended Warranty</b>                                      |                                     |                                     |                                     |
| Audi Extended Warranty   | <input checked="" type="checkbox"/> | <input checked="" type="checkbox"/> | <input checked="" type="checkbox"/> |

- Standard equipment  
 Optional equipment  
 Standard/optional equipment varies by model  
 – Not available

Country-specific variations possible. Please find out from your local Audi partner which equipment is standard and what optional equipment is available in your country. More detailed descriptions of a selection of items from the equipment range can be found from page 44 onwards.

- <sup>1</sup> For information on when this feature will be available, please contact your Audi Partner.  
<sup>2</sup> Only available in conjunction with S line sport package or S line exterior package.  
<sup>3</sup> From quattro GmbH.  
<sup>4</sup> Please note the special information relating to wheels on page 71.  
<sup>5</sup> Standard for engine models from 140 kW.  
<sup>6</sup> Standard for Audi design selection.  
<sup>7</sup> Only available in conjunction with S line sport package.  
<sup>8</sup> Only available in conjunction with sport seats with seat ventilation.  
<sup>9</sup> Only available in conjunction with Audi design selection.  
<sup>10</sup> Only available in conjunction with Audi exclusive leather package.  
<sup>11</sup> Standard for A4 Avant and on vehicles with quattro drive.  
<sup>12</sup> Standard in conjunction with Audi Matrix LED headlights.  
<sup>13</sup> Only available for A4 Avant.  
<sup>14</sup> Only available in conjunction with gloss package.  
<sup>15</sup> Only available for A4 Saloon.  
<sup>16</sup> Tracking system available for retrofitting from Audi Genuine Accessories.  
<sup>17</sup> Only available in conjunction with MMI navigation plus and Audi connect.  
<sup>18</sup> For information about the compatibility of your smartphone, please contact your mobile phone manufacturer.  
<sup>19</sup> Only available for TDI models.  
<sup>20</sup> Please contact your Audi partner or visit [www.audi.com/mp3](http://www.audi.com/mp3) for information on compatible media players.

#### Legal information regarding Audi connect

Use of the services supported by Audi connect is possible only with the optional MMI navigation or MMI navigation plus equipment and with Audi connect. You also require a SIM card with data option and with LTE option<sup>18</sup> to use LTE.

In conjunction with the optional equipment Audi phone box, a SIM card with phone and data option or a Bluetooth-compatible smartphone with remote SIM Access Profile (rSAP)<sup>20</sup> is required for the use of the integrated car phone function. The services are available only in conjunction with an existing or separate mobile phone contract and only within the range of the respective mobile phone network. Additional costs may be incurred when receiving data packets from the internet, depending on the terms of your mobile phone contract, particularly when used abroad. Because of the high data volumes involved, a data flat rate is strongly recommended. The availability of the services supported by Audi connect varies from country to country. For MMI navigation plus and MMI navigation in conjunction with the optional Audi connect: Audi connect services are available for at least 1 year from vehicle delivery. After 24 months have expired, Audi connect services will be extended free of charge once for 12 months. If you do not require this free extension, please write to:

AUDI AG

Audi International Customer Care Services  
 85045 Ingolstadt, Germany  
 Email: [kundenbetreuung@audi.de](mailto:kundenbetreuung@audi.de)  
 Tel: +49 (0)800 -2834 7378423

Ask your Audi partner about a subsequent extension of the Audi connect services. For MMI navigation without the optional Audi connect: the Audi connect services are available free-of-charge for a trial period of approx. 3 months from vehicle delivery. Ask your Audi partner about a subsequent fee-based extension of the Audi connect services. Audi connect allows access to Google and Twitter services. Permanent availability cannot be guaranteed, Google and Twitter are responsible for this. Please visit [www.audi.com/connect](http://www.audi.com/connect) or contact your Audi partner for more detailed information about Audi connect; contact your mobile services provider for information about contract conditions.

#### Legal information regarding Audi tablet

The functions of the Audi tablet may vary by region. Mobile charges may be incurred. The vehicle data that can be displayed depends on the vehicle and the equipment. The navigation function requires an Audi connect Wi-Fi hotspot and internet access, in some countries exclusively follow mode with display of current vehicle position. The Google Play Store function requires internet access.

**AUDI AG**  
85045 Ingolstadt  
www.audi.com  
Valid from September 2015

Printed in Germany  
533/1153.40.18

The models and equipment versions illustrated and described in this brochure and some of the services listed are not available in all countries. Some of the cars illustrated are equipped with optional features for which an extra charge is made. Details concerning the delivery specifications, appearance, performance, dimensions and weights, fuel consumption and running costs of the vehicle were correct to the best of our knowledge at the time of going to press. Deviations from the colours and shapes shown in the illustrations may occur. No liability is accepted for errors and printing errors. The right to introduce modifications is reserved. Not to be reproduced, including in part, without the written approval of AUDI AG.

This brochure is printed on paper made from pulp bleached without the use of chlorine.

